



SYNTHESIS AND ANALYSIS OF LINEAR, DISCRETE AND TIME-INVARIANT SYSTEMS, USED IN THE FIELD OF COMMUNICATIONS, USING MATLAB AND SIGNAL PROCESSING TOOLBOX

Daniel R. Denev, Tsvetoslav S. Tsankov

*KONSTANTIN PRES LAVSKI UNIVERSITY OF SHUMEN, 115 UNIVERSITETSKA,
SHUMEN 9700,*

E-mail: slimshady33@abv.bg, c.cankov@shu.bg

ABSTRACT: *Synthesis and Analysis of Linear Discrete Time-Invariant Systems Applied in Communications Using MATLAB and Signal Processing Toolbox: The paper presents the main steps in the process of synthesizing and analyzing linear discrete time-invariant systems applied in the field of communications. The simulation results of the systems implementing pre-emphasis and de-emphasis and removing DC offset are given in the paper such as impulse responses, frequency responses and pole-zero plots using MATLAB and Signal Processing Toolbox.*

KEY WORDS: *Linear discrete time-invariant systems, Pre-emphasis, De-emphasis, Removing DC offset*

1. Introduction

In recent years, digital signal processing has become increasingly necessary, and its special feature is the presentation of signals in digital form, which requires the construction of appropriate processing systems of digital elements. The field of application of digital signal processing is constantly expanding. Today, such areas of application of digital signal processing can be indicated, such as radio, hydro and sound localization, phase auto-tuning of the frequency in space radio communication, spectrum analysis, reception of signals with discrete frequency modulation, adaptive correction of communication channels, speech analysis in synthetic telephony systems, processing of phototelevision information, computer

modeling of dynamic systems, signal processing in meteorology, seismology and medicine, etc.

Digital signal processing is performed with systems that have different properties. The most widely used are linear, discrete and time-invariant systems.

The article examines linear, discrete and time-invariant systems that are widely used in communications, such as speech spectrum correctors in the GSM system and a circuit for removing the DC component in a complex signal, by simulation with MATLAB and Signal Processing Toolbox.

2. Exposure

In order to improve the quality of speech transmission in telecommunication systems, the GSM standard uses speech spectrum correction, and when transmitting the high-frequency components of the speech signal are raised after the analog-to-digital converter, known as pre-emphasis, and when receiving before digital -the analog converter is reversed, known as de-emphases (Fig. 1) [1, 2]. The correction of the spectrum in the GSM system is necessary due to the low level of the high-frequency components in the original speech signal and their importance for more accurate determination of the parameters of the resonators of the human speech tract.

A non-recursive linear, discrete and time-invariant first-order system with a differential equation is used for pre-correction:

$$(1) \quad y(n) = x(n) - 0,86 * x(n - 1).$$

After applying the right of z-transformation to two sides of equation (1) make:

$$(2) \quad Y(z) = X(z) - 0,86 * z^{-1} * X(z),$$

where the expression for the transfer function of the system is derived:

$$(3) \quad H(z) = \frac{Y(z)}{X(z)} = 1 - 0.86 * z^{-1}.$$

The transmission coefficient (the transmission function in the frequency domain) is obtained by substitution $z = e^{j\omega}$:

$$(4) \quad H(e^{j\omega}) = 1 - 0.86 * e^{-j\omega} = 1 - 0.86 * \cos \omega + j * 0.86 * \sin \omega,$$

where the hence expression for the amplitude-frequency characteristic (frequency response) of the system is described by equation (1) is

$$(5) H(\omega) = |H(e^{j\omega})| = \sqrt{(1 - 0.86 * \cos \omega)^2 + (0.86 * \sin \omega)^2} = \sqrt{1 - 2 * 0.86 * \cos \omega + 0.86^2}.$$

The two characteristic points on the amplitude-frequency of the characteristics are obtained at $\omega = 0$ and $\omega = \pi$ after substitution in expression (5) and show a significant increase in the high-frequency components of the spectrum relative to the low-frequency

$$(6) H(0) = \sqrt{1 - 2 * 0.86 * \cos 0 + 0.86^2} \Rightarrow H(0)_{dB} = 20 \lg * 0.14 = -17.0774 dB,$$

$$(7) H(\pi) = \sqrt{1 - 2 * 0.86 * \cos \pi + 0.86^2} \Rightarrow H(\pi)_{dB} = 20 \lg * 1.86 = 5.3903 dB.$$

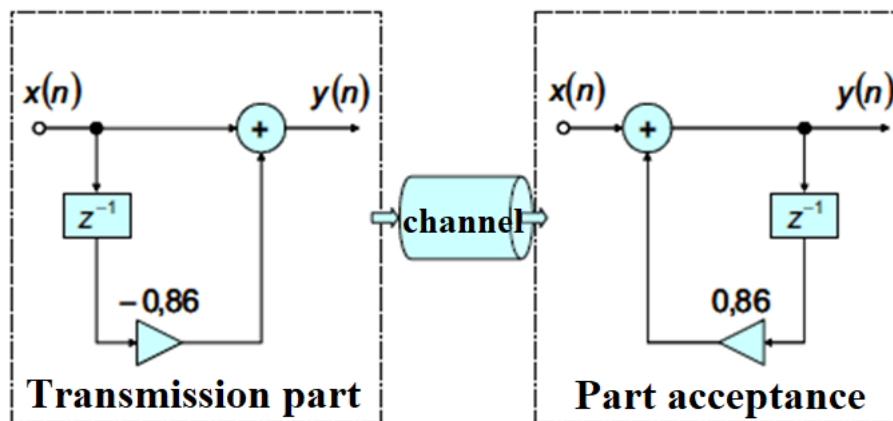

Fig. 1. Correctors of the speech spectrum in the GSM system

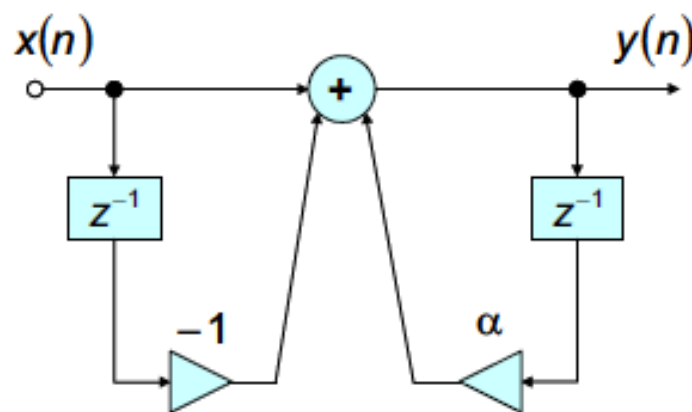

Fig. 2. Separator circuit to remove the permanent ingredient

The inverse correction (Fig. 1) is performed with a recursive linear, discrete and time-invariant system of the first order, described by the differential equation:

$$(8) \quad y(n) = x(n) + 0,86 \cdot y(n - 1).$$

The expressions for the transmission function, the transmission coefficient in the frequency range and the amplitude-frequency characteristic are derived similarly:

$$(9) \quad H(z) = \frac{Y(z)}{X(z)} = \frac{1}{1 - 0,86 \cdot z^{-1}},$$

$$(10) \quad H(e^{j\omega}) = \frac{1}{1 - 0,86 \cdot e^{-j\omega}} = \frac{1}{1 - 0,86 \cdot \cos \omega + j \cdot 0,86 \cdot \sin \omega},$$

$$(11) \quad H(\omega) = |H(e^{j\omega})| = \frac{1}{\sqrt{(1 - 0,86 \cdot \cos \omega)^2 + (0,86 \cdot \sin \omega)^2}} = \frac{1}{\sqrt{1 - 2 \cdot 0,86 \cdot \cos \omega + 0,86^2}}.$$

The two characteristic points of the amplitude-frequency characteristic are obtained at $\omega = 0$ and $\omega = \pi$ after substitution in expression (11):

$$(12) \quad H(0) = \frac{1}{\sqrt{1 - 2 \cdot 0,86 \cdot \cos 0 + 0,86^2}} \Rightarrow H(0)_{dB} = 20 \lg * 7.1429 = 17.0774 \text{ dB},$$

$$(13) \quad H(\pi) = \frac{1}{\sqrt{1 - 2 \cdot 0,86 \cdot \cos \pi + 0,86^2}} \Rightarrow H(\pi)_{dB} = 20 \lg * 0.5376 = -5.3903 \text{ dB}.$$

It should be noted that the product of the expressions for the amplitude-frequency characteristics of the two correctors is a unit, which determines a uniform equivalent amplitude-frequency characteristic. To remove the constant component of a complex signal can be used the so-called separation circuit (Fig. 2) [1, 2], described by the differential equation:

$$(14) \quad y(n) = x(n) - x(n - 1) + \alpha y(n - 1).$$

Such a system with $\alpha \approx 0,999$ is used to remove the constant component of the speech signal after the analog-to-digital converter in the software of the cellular phones of the GSM system. The expressions for the transmission function, the transmission coefficient in the frequency range and the amplitude-frequency characteristic of this system are:

$$(15) H(z) = \frac{Y(z)}{X(z)} = \frac{1-z^{-1}}{1-\alpha*z^{-j\omega}}$$

$$(16) H(e^{j\omega}) = \frac{1-z^{-j\omega}}{1-\alpha*z^{-j\omega}}$$

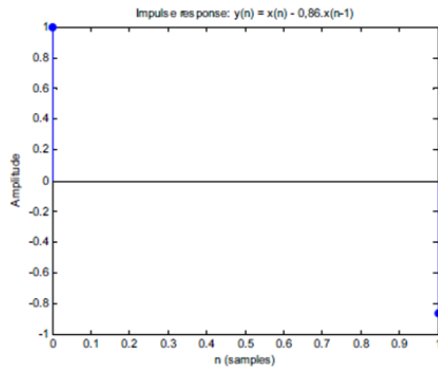

A)

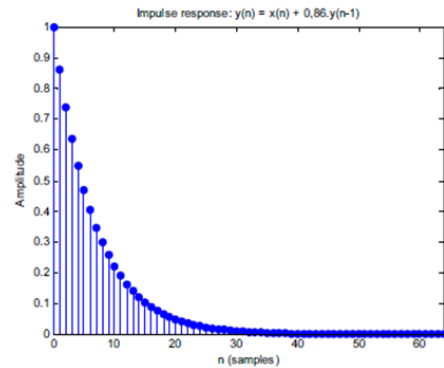

B)

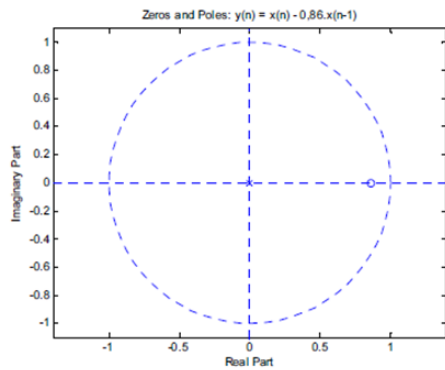

C)

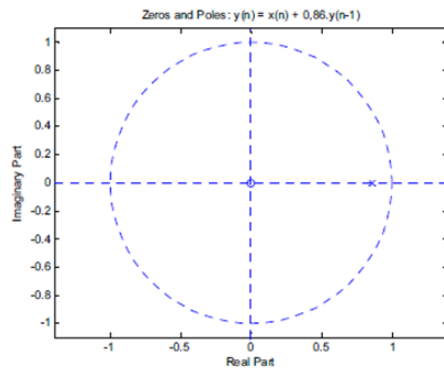

D)

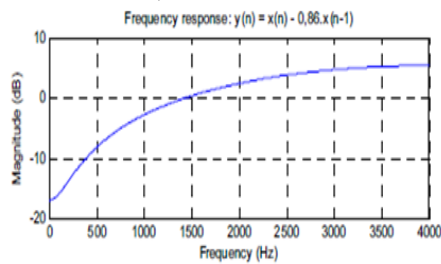

E)

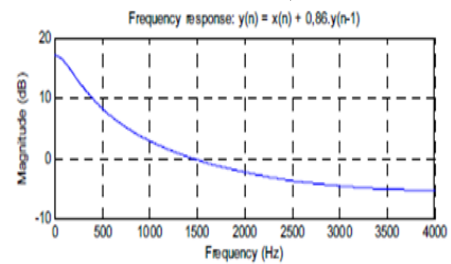

F)

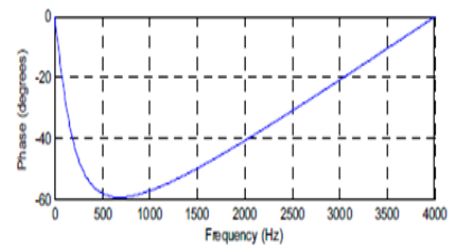
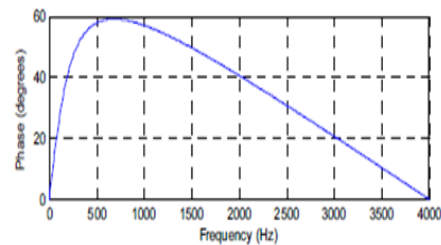

Fig. 3. Simulation results from the study of speech spectrum correctors in GSM system:

- IX of a pre-emphasis system;
- IX of a de-emphasises system;
- HDPE of a pre-emphasis system;
- HDPE of a de-emphasises system;
- frequency response and PCH of a pre-emphasis system;

Frequency response and PFC of a de-emphasises system

The simulation algorithm contains the following steps:

- Enter the coefficients in the numerator and denominator of the transfer function of the system, defined in MATLAB as a vector-line, respectively b and a:
- for speech spectrum correctors: $b = [1 \ -0.86]$, $a = 1$ (in the transmitting part) and $b = 1$, $a = [1 \ -0.86]$ (in the receiving part); for the separation circuit realizing the removal of the constant component: $b = [1 \ -1]$, $a = [1\text{-}\alpha]$ (for a given alpha).
- Drawing the impulse response (IH) of the system.
- Drawing the pole-zero diagram (HDD) of the system.
- Drawing of the amplitude-frequency and phase-frequency characteristics of the system (frequency response and PFC).

Display of the input and output signal for the isolating circuit with presetting of the amplitude of the DC component and the parameters (frequency and amplitude) of the sinusoidal signal [1, 3].

In Fig. 3 [3] shows the results of the simulation study of the speech spectrum correctors in the GSM standard, and in Fig. 4 [3] of the separation circuit described by the differential equation (14), for two different values.

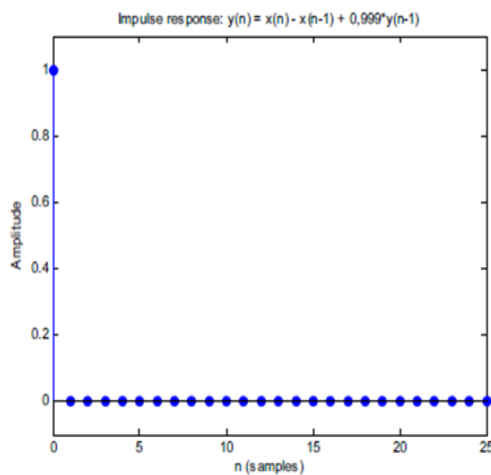

A)

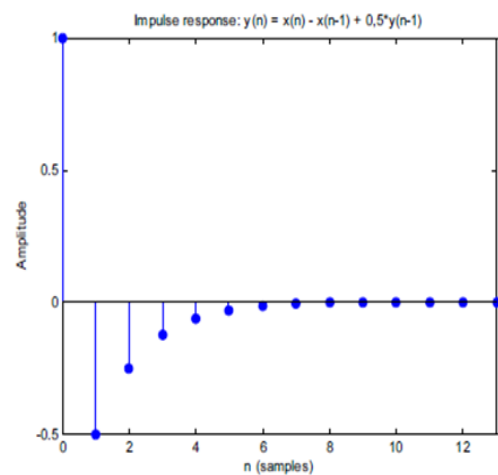

B)

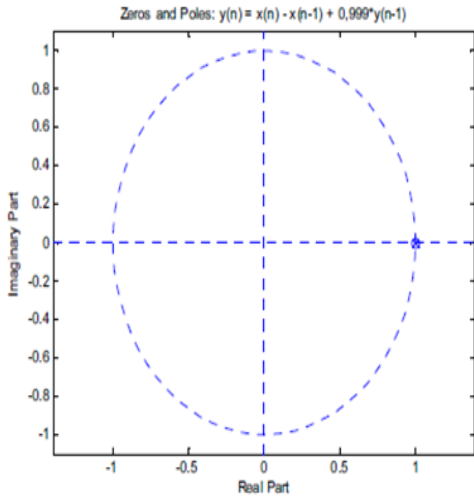

C)

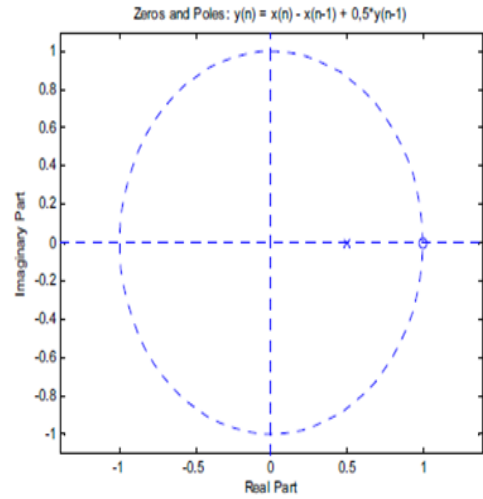

D)

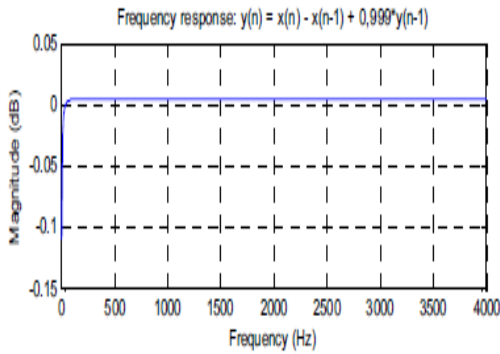

E)

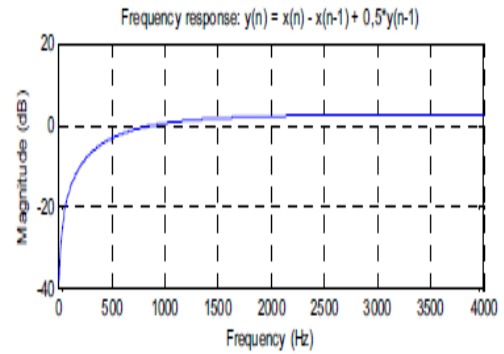

F)

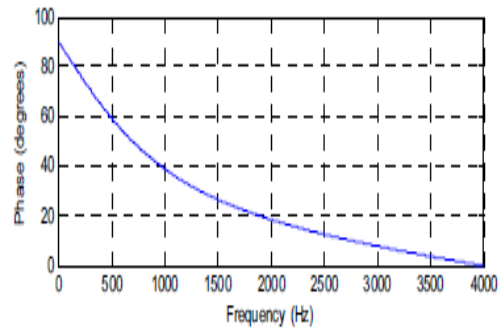
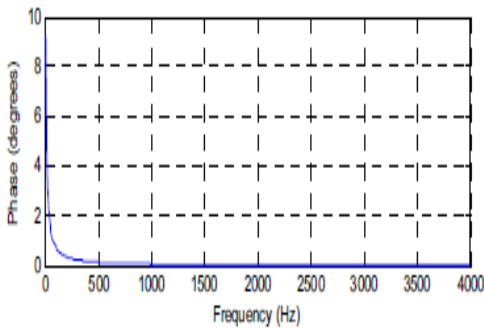

Fig. 4. Simulation results from the separation circuit study:

- IX at $\alpha = 0.999$;
- IX at $\alpha = 0.5$;
- HDPE at $\alpha = 0.999$;
- HDPE at $\alpha = 0.5$;
- frequency response and PFC at $\alpha = 0.999$;
- frequency response and PCH at $\alpha = 0.5$

The shape of IX at $\alpha = 0.999$ (Fig. 4, a) [3] is close to the shape of the digital single pulse, which is a prerequisite for small distortions when a signal passes through the system. At $\alpha = 0.5$, the shape of IX (Fig. 4, b) already differs from that of the digital single pulse. In both cases, IX is decreasing over time, therefore the system is stable. The HDPE at both values of α (Fig. 4, in at $\alpha = 0.999$ and Fig. 4, d at $\alpha = 0.5$) contains one zero and one pole falling inside the unit circle, which is also an indicator of the stability of the system. At $\alpha = 0.999$, the pole almost coincides with the zero of the system. The frequency response at $\alpha = 0.999$ (Fig. 4, e) shows the uniform transmission of the spectral components in a wide frequency range except for a very narrow range, close to zero frequency. At $\alpha = 0.5$, the frequency response (Fig. 4, e) also shows the uniform transmission of the spectral components over a wide frequency range, but a significantly wider transition region is obtained (up to 1000 Hz) [2, 3].

In Fig. 5 [3] with a dotted line shows an input signal containing a constant component with an amplitude of 0.25 V and a harmonic (sinusoidal) signal with an amplitude of 1 V and a frequency of 400 Hz, and with a solid line is given the corresponding output signal of the isolating circuit at $\alpha = 0,97$. There is a rapid attenuation of the step function (constant level) and the transfer of the harmonic component without attenuation.

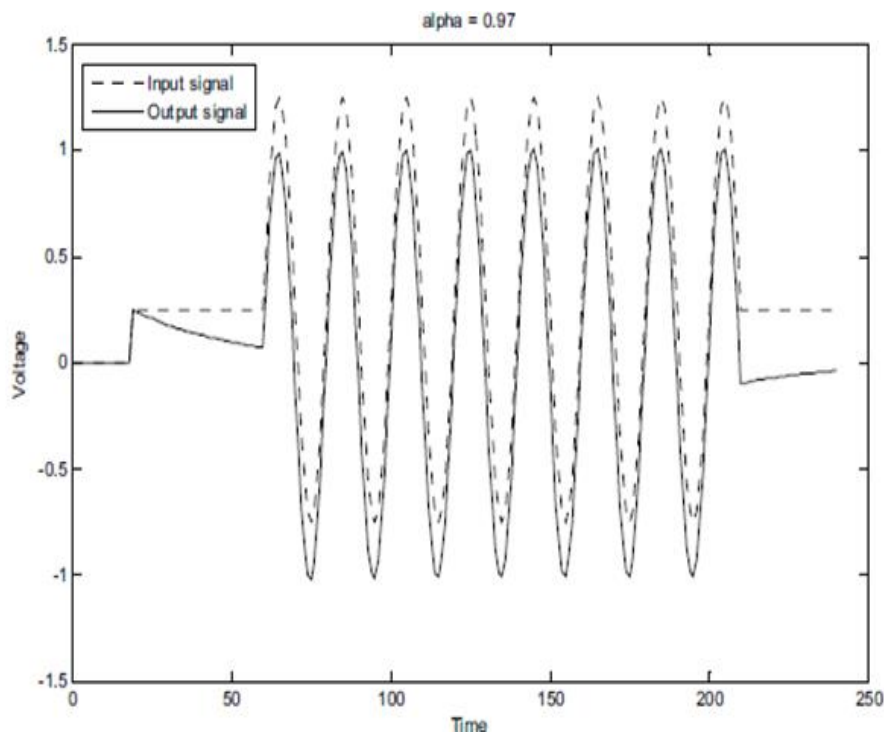

Fig. 5. Input and output signal for isolating circuit at $\alpha = 0,97$

3. Conclusion

The article presents and analyzes the results of the simulation study of linear, discrete and time-invariant systems, widely used in the field of communications, in particular in the GSM standard, such as speech spectrum correctors and isolating circuit for DC component removal in complex signal. The algorithm is programmatically implemented through MATLAB and Signal Processing Toolbox, and the obtained pole-zero diagrams, pulse and frequency characteristics are analyzed. The article illustrates the removal of the DC component of a complex signal

Reference:

- [1]. Boyanov B. Tsifrova obrabotka na signali, chast I. Bryag-print, Varna, 2003.
- [2]. Donevski, B., G. Nenov. Tsifrovi filtri. Sofiya, Tehnika, 1982.
- [3]. www.mathworks.com